

City of Childersburg

COUNCIL MEMBERS:

ANGIE TWYMON
MAYOR PRO TEMPORE
MICHAEL McLAIN
BILL MOODY
BRANDON ROBINSON
T. GLENN STUBBLEFIELD



KEN WESSON
MAYOR

AIMEE P. BURNETTE
CITY CLERK/TREASURER

Manufactured (MOBILE) Home Requirements:

Alabama Manufactured Housing Commission

- Manufactured Homes and Manufactured (Modular) buildings must be installed by a "certified" installer who must place their installation decal (showing the date and name and certification number of the installer) on the home or building prior to starting the setup.
- Fire separation requirements contained in **Paragraph 4-2.1 of NFPA**: Any portion of a manufactured home, excluding the tongue, shall not be located closer than 10 ft. (3m) side to side, 8 ft. (2.4m) end to side, or 6 ft. (1.8m) end to end horizontally from any other manufactured home or community building unless the exposed composite walls and roof of either structure are without openings and constructed of materials that will provide a one (1) hour fire rating or the structures are separated by a one (1) hour fire rated barrier.

1. Must be in correct zoning area, AG, R-2, R-3 or Mobile Home Park
2. Must have a City of Childersburg Manufactured Home Permit
3. A HUD Seal is required
4. Must be anchored to meet code requirements, so no water can accumulate under home. Must apply a ground cover of 6 mil polyethylenes sheeting to cover the area under the home.
5. Axles are to be removed and skirting is to be installed on exterior walls of block, brick or weather resistant material.
6. A minimum size 8 ft. wide, 5 ft. deep front porch, with 3 ft. wide steps, with handrails. (See drawings) All other entrances shall have a 3 ft. wide set of steps with handrails.
7. Water and sewer service must be installed prior to occupation.
8. Establish garbage service through Childersburg City Hall.
9. Must use a state licensed electrician to install service. An electrical is permit required.
10. Mobile Home Mover should be licensed by the City of Childersburg

**YOU MUST MEET ALL OF THESE REQUIREMENTS AND
CONDITIONS BEFORE ELECTRICAL SERVICE IS RELEASED!!!!!!**

City of Childersburg

COUNCIL MEMBERS:

ANGIE TWYMON
MAYOR PRO TEMPORE
MICHAEL McLAIN
BILL MOODY
BRANDON ROBINSON
T. GLENN STUBBLEFIELD



KEN WESSON
MAYOR

AIMEE P. BURNETTE
CITY CLERK/TREASURER

Manufactured Homes Requirements for obtaining permit and specifications (All homes shall comply with the following, prior to occupancy.)

1. Survey of lot or land where home is to be located. (Not needed if home is in Mobile Home Park.)
2. Street address where home is to be located.
3. H.U.D. seal is required. Prior to installation, each manufactured home shall bear a seal certifying compliance with the Manufactured Home Construction and Safety Standards Act promulgated by the U.S. Department of Housing and Urban Development.
4. Anchoring Requirements: All manufactured homes shall be set up, installed, and anchored in full compliance with the requirements of the Alabama Manufactured Housing Commission.
5. Skirting required: All manufactured homes not otherwise placed on a permanent foundation shall be skirted with weather-resistant material, which resembles a permanent foundation commonly found on a single family dwelling. Skirting shall be adequately vented.
6. Axles and tow bars removed. Once a manufactured home has been placed on an individual lot, all tow bars and axles shall be removed and stored in a location on the lot where they will not be seen from the street or neighboring homes.
7. Access to exterior entrances: Immediately after installation and prior to occupation, steps and a landing or porch shall be constructed at each raised exterior entrance or doorway to the manufactured home. At a minimum, all entrances to manufactured home shall be served by a stairway not less than three (3) feet in width. The main entrance shall have a porch five (5) feet by five (8) feet minimum. See attached drawing for size and construction details.
8. Sanitary facilities: Each manufactured home shall contain at least one shower or tub, a flush toilet, a lavatory, hot and cold running water, and a central source of heat for occupants.
9. Compatibility with adjoining residential properties. While the City of Childersburg acknowledges and accepts its responsibility to promote a wide range of affordable housing styles for its residents, it also must recognize that manufactured homes are a distinct type of housing that can under certain circumstances alter or disrupt the stability of property values and character of established residential neighborhoods that consist predominately, or exclusively of site-built single family detached dwellings. Therefore, manufactured homes may be permitted on a vacant lot within as AG, R-2, or R-3 zoning district only in full compliance with the following special conditions:
 - A. The proposed manufactured home will not be located on a vacant lot that is within a designated local, state, or federal historic district, or a vacant lot that is between two (2) or more structures that has been listed on, or are eligible for addition the National Register of Historic Places; and
 - B. The combined value of the proposed manufactured home and the property upon which it will be sited shall not be less than ninety (90) percent of the average fair market value of all adjoining properties that have been improved for single family residential use according to the property value records maintained by the County Assessor's Office.
10. Contractor or homeowner is responsible for calling for an inspection when ready.

**CITY OF CHILDERSBURG
MANUFACTURED HOMES APPLICATION**

201 8TH AVENUE S.W./POST OFFICE BOX 369; CHILDERSBURG, ALABAMA 35044

DATE: _____ PERMIT #: MH _____

ELECTRICAL CONTRACTOR: _____ ST. LIC. # _____ CITY LIC. # _____

PLUMBING CONTRACTOR: _____ ST. LIC. # _____ CITY LIC. # _____

HVAC CONTRACTOR: _____ ST. LIC. # _____ CITY LIC. # _____

ADDRESS OF MOBILE HOME: _____

MOBILE HOME PARK (IF APP): _____

WHAT NAME IS POWER APPLIED IN? _____

MAILING ADDRESS: _____ CITY _____ ST _____ ZIP _____

DAYTIME PHONE #: _____ CELL # _____ MSG. # _____

PROPERTY OWNER'S NAME: _____

MAILING ADDRESS: _____ CITY _____ ST _____ ZIP _____

DAYTIME PHONE #: _____ CELL # _____ MSG. # _____

LOT # OR MAP ID#: _____ SEPTIC TANK _____ SEWER _____

MOBILE HOME DESCRIPTION: MAKE _____ SIZE _____ SERIAL _____
YEAR _____ COLOR _____

IS THIS A RECENT PURCHASE? _____ IF YES, FROM WHOM: _____ CITY BL# _____

SELLER'S ADDRESS: _____ CITY _____ ST _____ ZIP _____

DIRECTIONS TO MOBILE HOME: _____

APPLICANT'S SIGNATURE: _____

APPLICANT'S PRINTED NAME _____

CONTRACTOR CONTACT # _____

PERMIT FEE: _____

STANDARD ISS. FEE _____

TOTAL FEE: _____

OFFICE USE ONLY

- Zoning approved by: _____
- Location on lot approved by: _____
- Permit approved by: _____
- Power approved by: _____
- Water approved by: _____
- Sewer approved by: _____
- Other approvals needed: _____

- PORCH AND STEPS
- ELECTRICAL SERVICE
- CALL WHEN INSPECTION IS NEEDED

- INSPECTIONS REQUIRED**
- SEWER AND WATER
- ANCHORING AND SKIRTING

TYPICAL DECK DETAIL

MIN SIZE 5FTX8FT

NOT TO SCALE

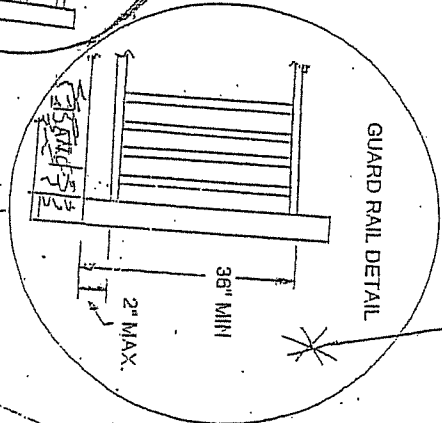
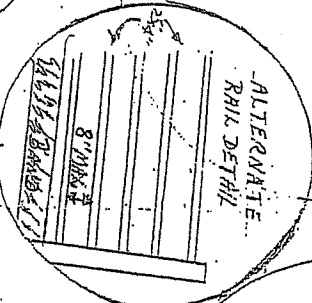
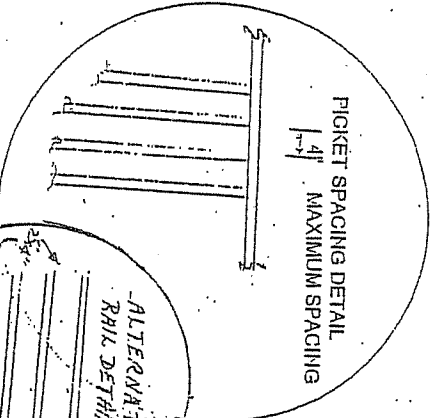
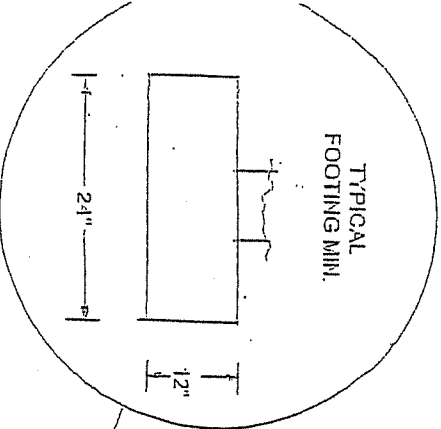
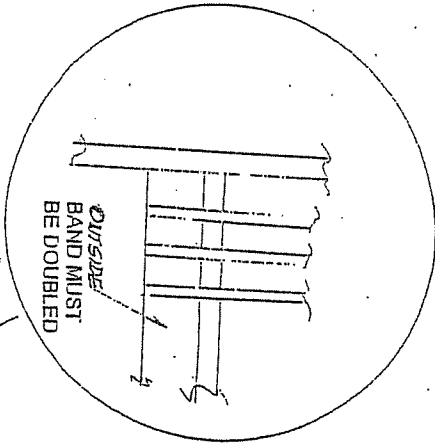

Note: If 48" For Fence (Deck) Around Pool.

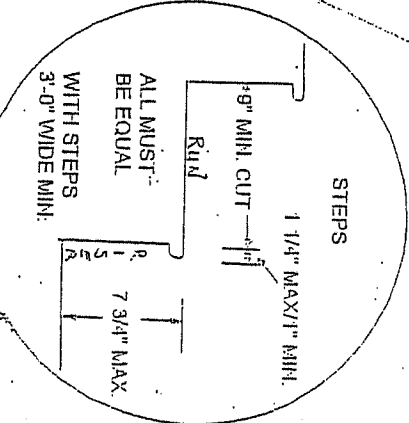
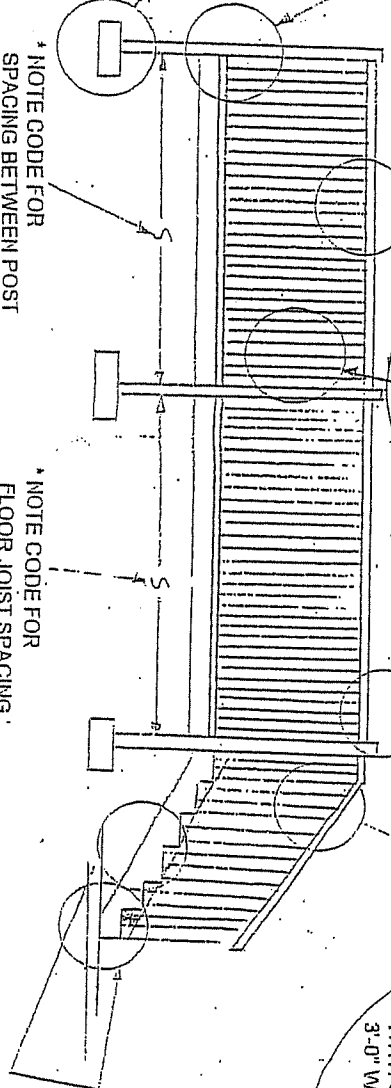
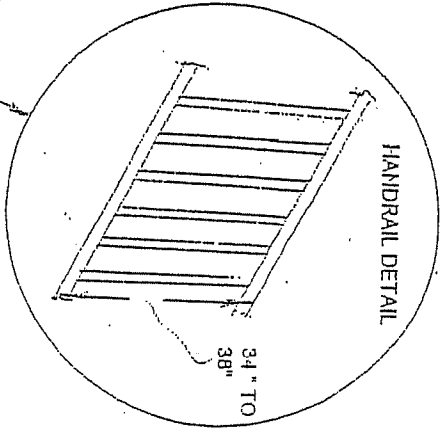

NOTE
1997 SBC
CODE STATES
MIN. 2 STEPS BY
- RISE WILL BE A
MIN. 21" AND MAX. 25"

* SPACE 6" MAX.